



INSTALLATION TIME ESTIMATED : 1 HOUR

| | | | |
|---|------------|------------------------------------|---------------------------------------|
|  | BMW | CANBUS 2 WIRES PROTOCOL | PLUG AND PLAY CBL059BMDB11 |
|---|------------|------------------------------------|---------------------------------------|

| Vehicle | Year | OEM Radio |
|-------------|------------|---|
| Series 1 | 2012-> | Only with equipment: - Business Radio - Business Navigation |
| Series 1 | 2005-2011 | All Models |
| Series 3 | 2005-2011 | All Models |
| Series 5 | 2005-2011 | All Models |
| Series 5 | 2012-> | Only with equipment: - Business Radio - Business Navigation |
| Series 5 GT | 2008-> | Only with equipment: - Business Radio - Business Navigation |
| X1 | 2009->2015 | All Models |
| X3 | 2010-> | Only with equipment: - Business Radio - Business Navigation |
| X5 | 2007-2011 | All Models |
| X6 | 2008-> | All Models |

| Connectors position: car radio compartment | ANTENNA ADAPTERS |
|--|--|
| Behind the car radio there are Fakra radio OEM connectors. | Code: CBL054ANDB21 |
|  |  |

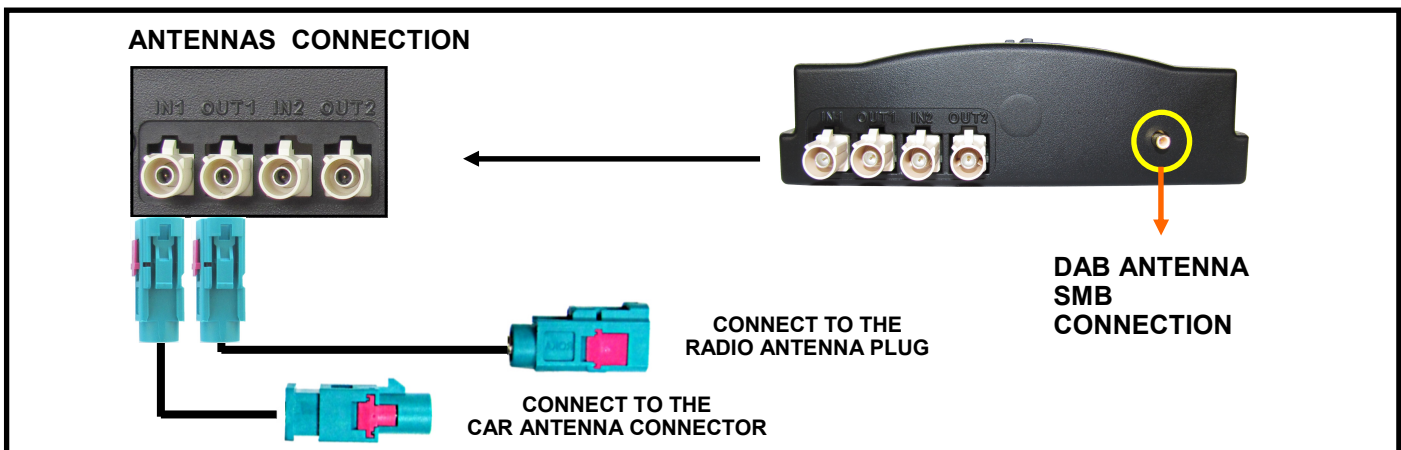











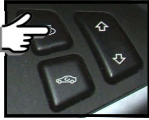

NOTE

PLEASE TUNE THE FM RADIO ON THE DEFAULT STATION AND STORE THE FREQUENCY 87.7 MHZ IN ONE OF FREE CHANNELS (I.E. POSITION 1). PLEASE POWER MEDIADAB HD: THE MODULE WILL START AND IT WILL ENABLE THE SCAN OPERATION, FOR WHICH IT NEEDS A FEW MINUTES. PLEASE MAKE SURE THAT THE CAR IS IN AN OPEN AREA AND THE DAB ANTENNA IS CONNECTED PROPERLY. ONCE THE SCANNER IS COMPLETE, IT WILL START TO PLAY THE FIRST DAB STATION AVAILABLE.

| | | | |
|---|-------------------|---|---|
|  | <p>BMW</p> | <p>CANBUS 2 WIRES PROTOCOL</p> | <p>PLUG AND PLAY CBL059BMD11</p> |
|---|-------------------|---|---|

QUICK MENU

| | |
|---|---|
| <p>ON VOLUME SEQUENCE</p> |  <p style="text-align: center;">VOL+ VOL- VOL+ VOL-</p> |
| <p>OFF VOLUME SEQUENCE</p> |  <p style="text-align: center;">VOL+ VOL- VOL+ VOL-</p> <p style="text-align: center;">OR THROUGH THE MENU</p> |
| <p>ENTER SEQUENCE MENU</p> |  <p style="text-align: right;">PRESS MODE LONG</p> |
| <p>SCROLL THE MENU SEEK KEYS</p> | <p style="text-align: center;">PREVIOUS</p>   <p style="text-align: right;">NEXT</p> |
| <p>CONFIRM A SELECTION PRESS MODE</p> | <p style="text-align: center;">SHORT PRESS</p>  |
| <p>CHANNEL CHANGE SEEK KEYS</p> | <p style="text-align: center;">PREVIOUS</p>   <p style="text-align: right;">NEXT</p> |
| <p>CHANNEL FAVOURITE CHANGE SEEK KEYS</p> | <p style="text-align: center;">LONG PREVIOUS PRESS</p>   <p style="text-align: right;">LONG NEXT PRESS</p> |
| <p>ADD FAVOURITE CHANNEL VOLUME SEQUENCE</p> |  <p style="text-align: center;">VOL- VOL+</p> |
| <p>SCAN</p> | <p style="text-align: center;">PRESS MODE 3 TIMES</p>  |

| | | | |
|---|-------------------|---|---|
|  | <p>BMW</p> | <p>CANBUS 2 WIRES PROTOCOL</p> | <p>PLUG AND PLAY CBL059BMD11</p> |
|---|-------------------|---|---|

QUICK MENU

| | |
|--|---|
| <p>ON VOLUME SEQUENCE</p> |  <p style="text-align: center;">VOL+ VOL— VOL+ VOL —</p> |
| <p>OFF VOLUME SEQUENCE</p> |  <p style="text-align: center;">VOL+ VOL— VOL+ VOL —</p> <p style="text-align: center;">OR THROUGH THE MENU</p> |
| <p>ENTER SEQUENCE MENU</p> |  <p style="text-align: right;">PRESS MODE LONG</p> |
| <p>SCROLL THE MENU SEEK KEYS</p> | <p style="text-align: center;">PREVIOUS</p>  <p style="text-align: right;">NEXT</p> |
| <p>CONFIRM A SELECTION PRESS MODE</p> |  |
| <p>CHANNEL CHANGE SEEK KEYS</p> | <p style="text-align: center;">PREVIOUS</p>  <p style="text-align: right;">NEXT</p> |
| <p>CHANNEL FAVOURITE CHANGE SEEK KEYS</p> | <p style="text-align: center;">LONG PREVIOUS PRESS</p>  <p style="text-align: right;">LONG NEXT PRESS</p> |
| <p>ADD FAVOURITE CHANNEL VOLUME SEQUENCE</p> |  <p style="text-align: center;">VOL— VOL+</p> |
| <p>SCAN</p> | <p style="text-align: center;">PRESS MODE 3 TIMES</p>  |