

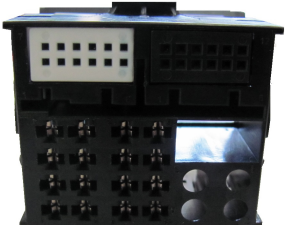
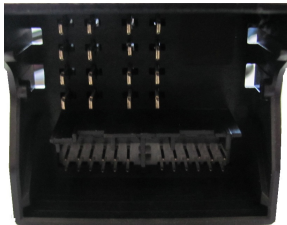

**INSTALLATION TIME ESTIMATED : 1 HOUR**

 Mercedes-Benz	<b>MERCEDES</b>	<b>CANBUS 2 WIRES PROTOCOL</b>	<b>PLUG AND PLAY CBL059MEDB11</b>
--	-----------------	------------------------------------	---------------------------------------

Vehicle	Year	OEM Radio
<b>Class A</b>	<b>2012-&gt;</b>	<b>All Models</b>
<b>Class A Fakra</b>	<b>2003-2011</b>	<b>All Models</b>
<b>Class B</b>	<b>2004-&gt;</b>	<b>All Models</b>
<b>Class C</b>	<b>2003-2014</b>	<b>All Models</b>
<b>Class CLK</b>	<b>2003-&gt;</b>	<b>All Models</b>
<b>Class E</b>	<b>2009-&gt;</b>	<b>All Models</b>
<b>Class E Coupe</b>	<b>2009-&gt;</b>	<b>All Models</b>
<b>Class GL</b>	<b>2006-&gt;</b>	<b>All Models</b>
<b>Class ML</b>	<b>2004-2005</b>	<b>All Models</b>
<b>Class ML</b>	<b>2006-2011</b>	<b>All Models</b>
<b>Class R</b>	<b>2006-2010</b>	<b>All Models</b>
<b>Class SLK</b>	<b>2012-&gt;</b>	<b>All Models</b>
<b>Sprinter Fakra</b>	<b>2007-&gt;</b>	<b>All Models</b>
<b>Viano</b>	<b>2005-&gt;</b>	<b>All Models</b>
<b>Vito</b>	<b>2005-&gt;</b>	<b>All Models</b>

Connectors position: car radio compartment	ANTENNA ADAPTERS
Behind the car radio there are Fakra radio OEM connectors. <div style="display: flex; justify-content: space-around; margin-top: 10px;">   </div>	Code: CBL054ANDB21 <div style="text-align: center; margin-top: 10px;">  </div>

**STANDARD CONNECTION**

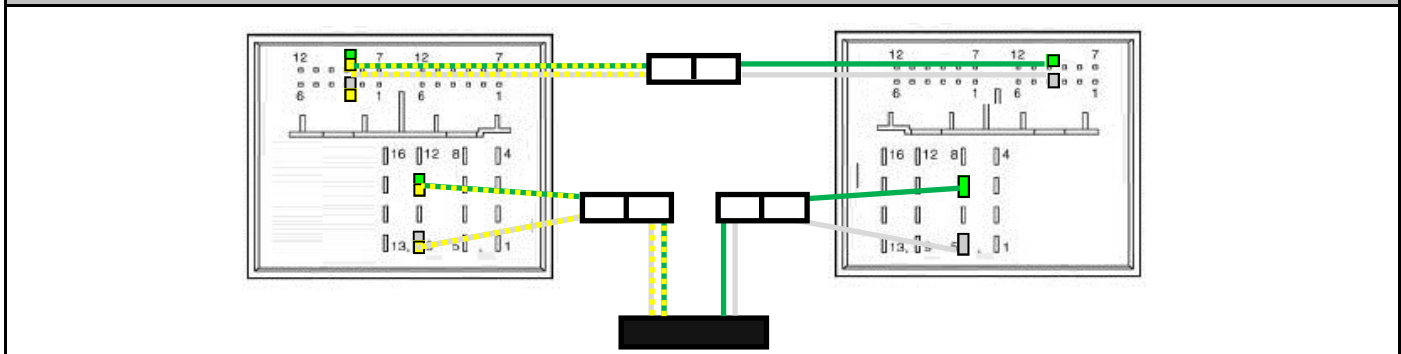

**ALTERNATIVE CONNECTION**

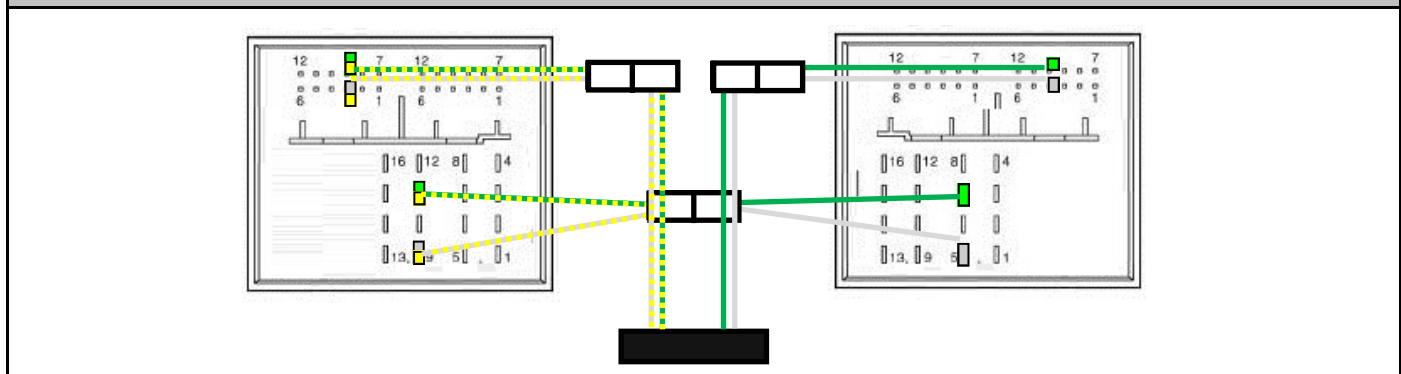



**NOTE**

PLEASE TUNE THE FM RADIO ON THE DEFAULT STATION AND STORE THE FREQUENCY 87.7 MHZ IN ONE OF FREE CHANNELS (I.E. POSITION 1). PLEASE POWER MEDIADAB HD: THE MODULE WILL START AND IT WILL ENABLE THE SCAN OPERATION, FOR WHICH IT NEEDS A FEW MINUTES. PLEASE MAKE SURE THAT THE CAR IS IN AN OPEN AREA AND THE DAB ANTENNA IS CONNECTED PROPERLY. ONCE THE SCANNER IS COMPLETE, IT WILL START TO PLAY THE FIRST DAB STATION AVAILABLE.

**INSTALLATION TIME ESTIMATED : 1 HOUR**

 Mercedes-Benz	<b>MERCEDES</b>	<b>CANBUS 2 WIRES PROTOCOL</b>	<b>PLUG AND PLAY CBL059MEDB11</b>
--	-----------------	------------------------------------	---------------------------------------

Connectors position: car radio compartment	ANTENNA ADAPTERS
Behind the car radio there are Fakra radio OEM connectors.  	Code: CBL054ANDB21  

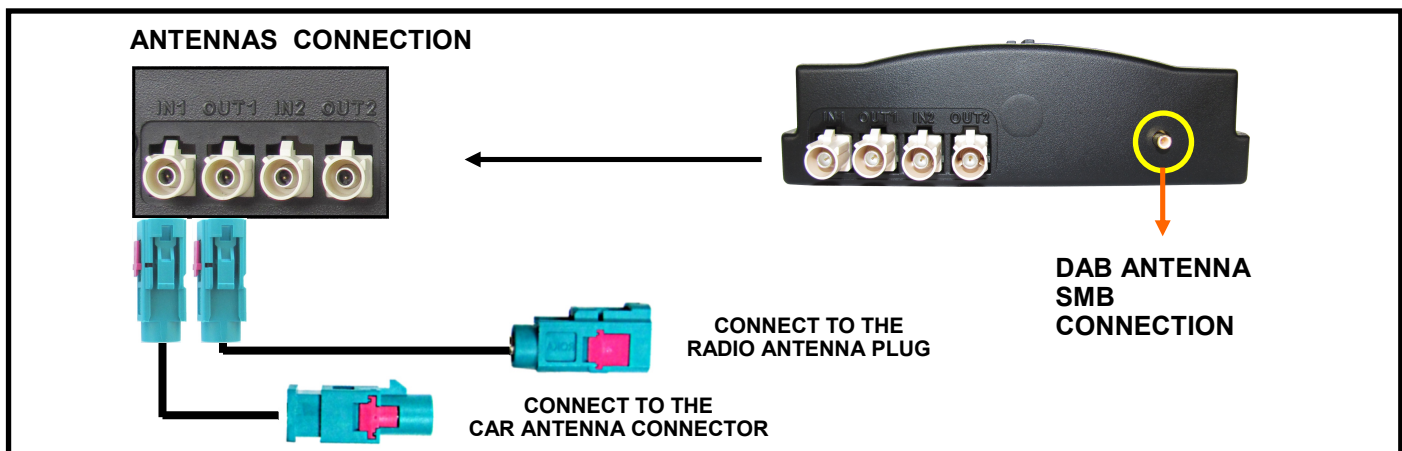

**NOTE**

PLEASE TUNE THE FM RADIO ON THE DEFAULT STATION AND STORE THE FREQUENCY 87.7 MHZ IN ONE OF FREE CHANNELS (I.E. POSITION 1). PLEASE POWER MEDIADAB HD: THE MODULE WILL START AND IT WILL ENABLE THE SCAN OPERATION, FOR WHICH IT NEEDS A FEW MINUTES. PLEASE MAKE SURE THAT THE CAR IS IN AN OPEN AREA AND THE DAB ANTENNA IS CONNECTED PROPERLY. ONCE THE SCANNER IS COMPLETE, IT WILL START TO PLAY THE FIRST DAB STATION AVAILABLE.





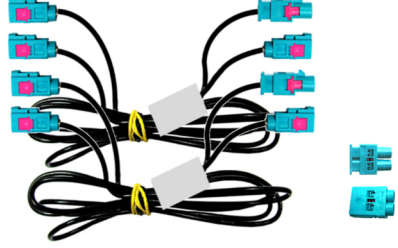

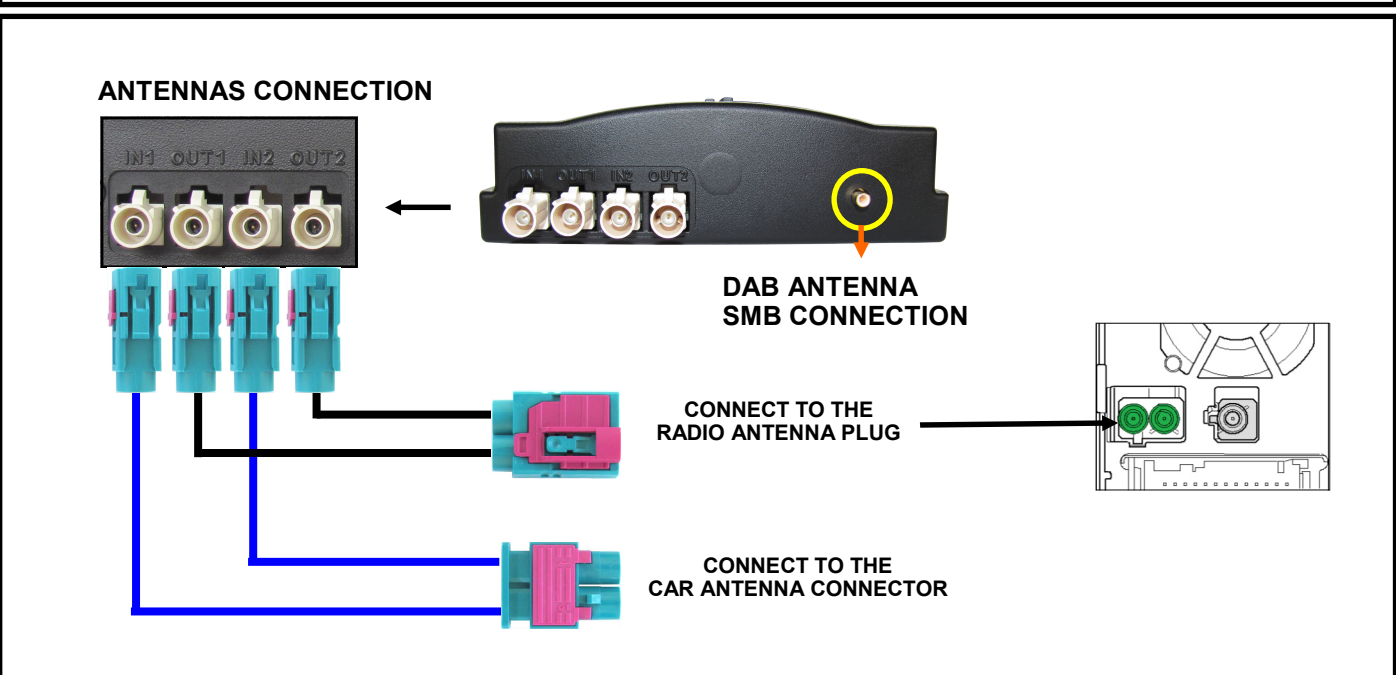
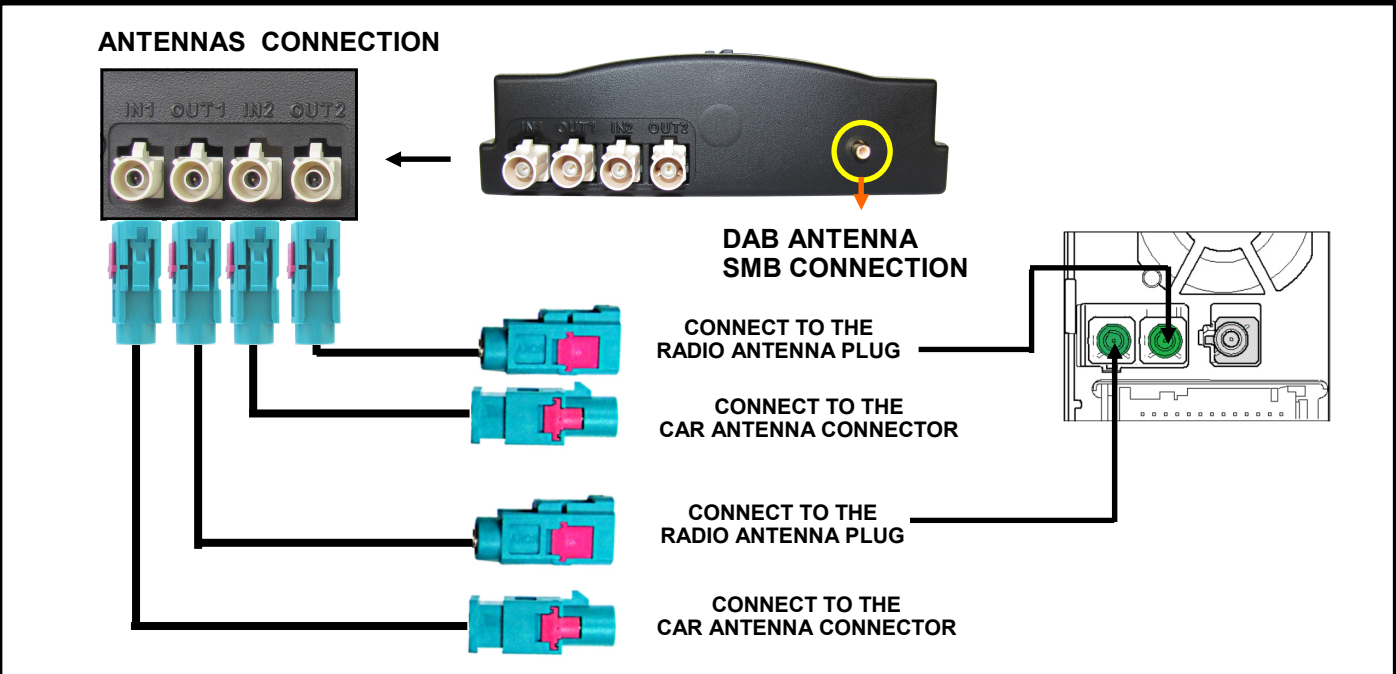











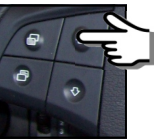

**INSTALLATION ESTIMATED IN 1 HOUR AND A HALF**

 Mercedes-Benz	<b>MERCEDES</b>	<b>CANBUS 2 WIRES PROTOCOL</b>	<b>PLUG AND PLAY CBL059MEDB11</b>
<b>IN CASE OF OEM RADIO WITH DOUBLE ANTENNAS</b>			

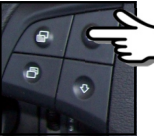







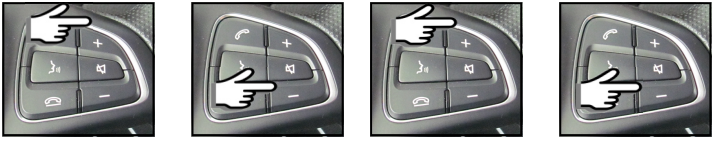
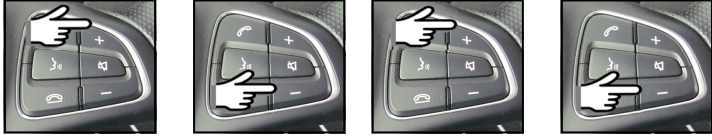

<b>Connector position: Radio location</b>	<b>ANTENNA ADAPTER</b>
Behind the radio there is the OEM radio connector. 	Code: <b>KIT054ANDB21</b> 



 Mercedes-Benz	<p><b>MERCEDES</b></p>	<p><b>CANBUS 2 WIRES PROTOCOL</b></p>	<p><b>PLUG AND PLAY CBL059MEDB11</b></p>
--	------------------------	---	--

<p><b>QUICK MENU</b></p>	
<p>SWITCH ON VOLUMES SEQUENCE</p>	 VOL+  VOL-  VOL+  VOL-
<p>SWITCH OFF VOLUMES SEQUENCE</p>	 VOL+  VOL-  VOL+  VOL-
<p>ENTER THE MENU SEEK SEQUENCE SEEK - SEEK + SEEK - SEEK +</p>	   
<p>NAVIGATE THE MENU SEEK BUTTONS</p>	<p><b>PREVIOUS</b>   <b>NEXT</b></p>
<p>CONFIRM A SELECTION SEEK SEQUENCE SEEK - SEEK +</p>	 
<p>CHANGE CHANNELS SEEK BUTTONS</p>	<p><b>PREVIOUS</b>   <b>NEXT</b></p>
<p>CHANGE FAVOURITE CHANNELS SEEK BUTTONS</p>	<p><b>LONG PRESS PREVIOUS</b>   <b>LONG PRESS NEXT</b></p>
<p>ADD CHANNEL TO FAVOURITE VOLUME SEQUENCE</p>	 VOL-  VOL+
<p>SCAN THROUGH MENU</p>	<p><b>THROUGH MENU</b></p>

 Mercedes-Benz	<p><b>MERCEDES</b></p>	<p><b>CANBUS 2 WIRES PROTOCOL</b></p>	<p><b>PLUG AND PLAY CBL059MEDB11</b></p>
--	------------------------	---	--

<p><b>QUICK MENU</b></p>	
<p>SWITCH ON VOLUMES SEQUENCE</p>	 <p>VOL+      VOL-      VOL+      VOL-</p>
<p>SWITCH OFF VOLUMES SEQUENCE</p>	 <p>VOL+      VOL-      VOL+      VOL-</p>
<p>ENTER THE MENU <b>LONG PRESS OK button</b></p>	 <p><b>LONG PRESS OK button</b></p>
<p>NAVIGATE THE MENU SEEK BUTTONS</p>	<p><b>PREVIOUS</b></p>   <p><b>NEXT</b></p>
<p>CONFIRM A SELECTION <b>SHORT PRESS OK button</b></p>	 <p><b>SHORT PRESS OK button</b></p>
<p>CHANGE CHANNELS SEEK BUTTONS</p>	<p><b>PREVIOUS</b></p>   <p><b>NEXT</b></p>
<p>CHANGE FAVOURITE CHANNELS SEEK BUTTONS</p>	<p><b>LONG PRESS PREVIOUS</b></p>   <p><b>LONG PRESS NEXT</b></p>
<p>ADD CHANNEL TO FAVOURITE VOLUME SEQUENCE</p>	 <p>VOL-      VOL+</p>
<p>SCAN</p>	 <p><b>3 TIMES OK button</b></p>